

Taza.

Carlos Pomaron Arbues

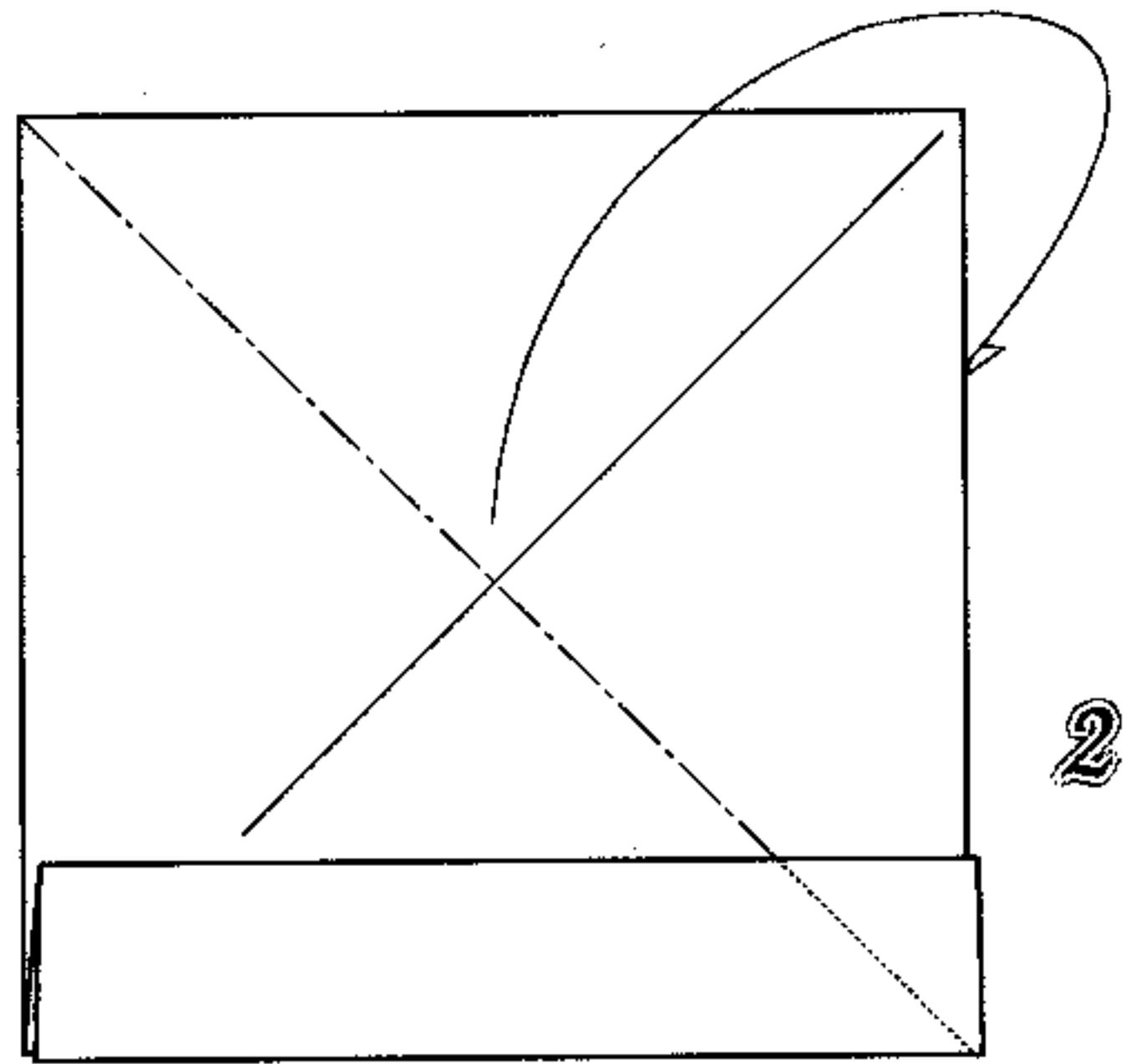

1

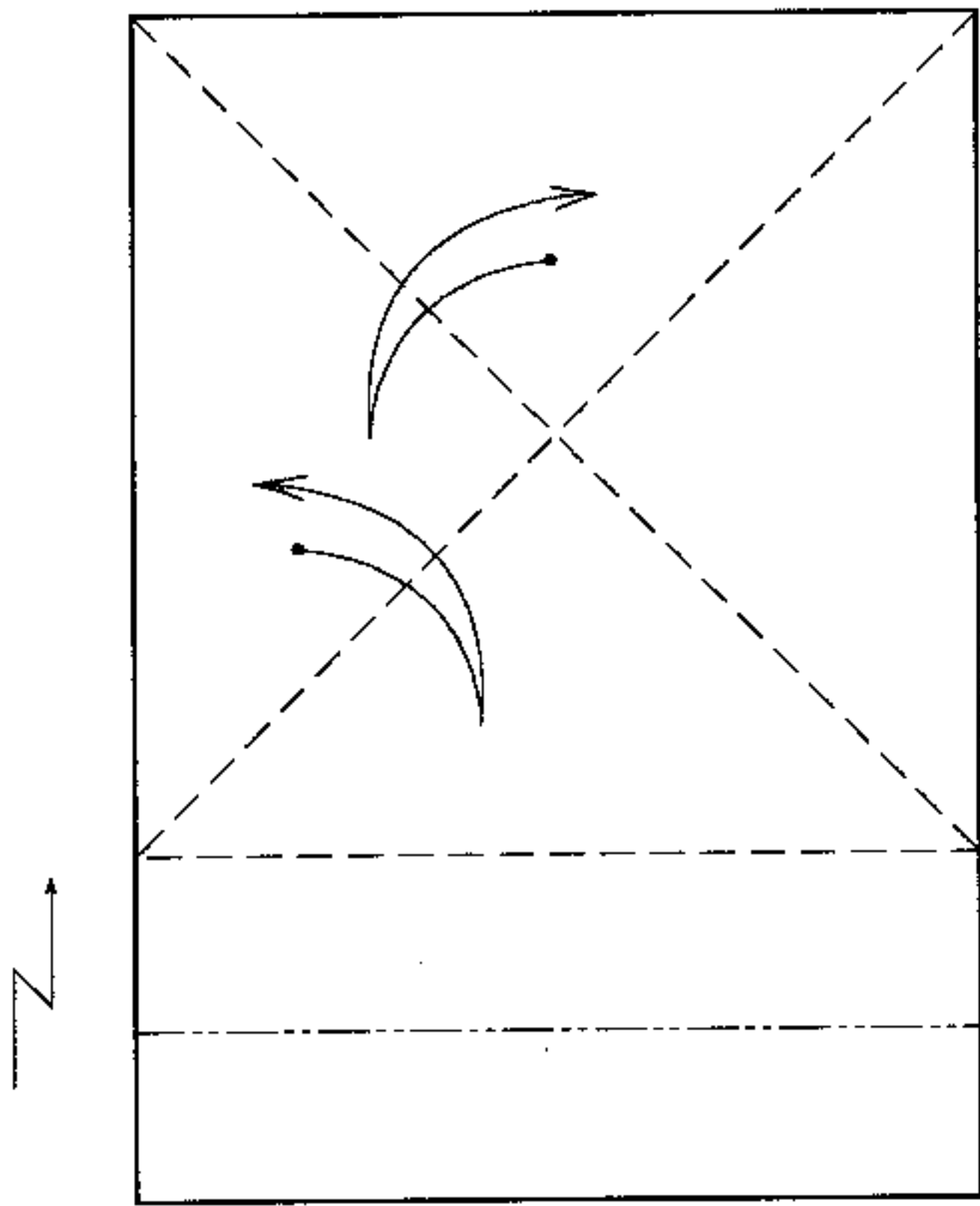
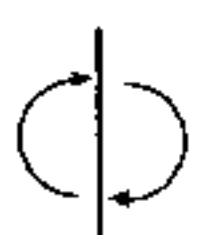
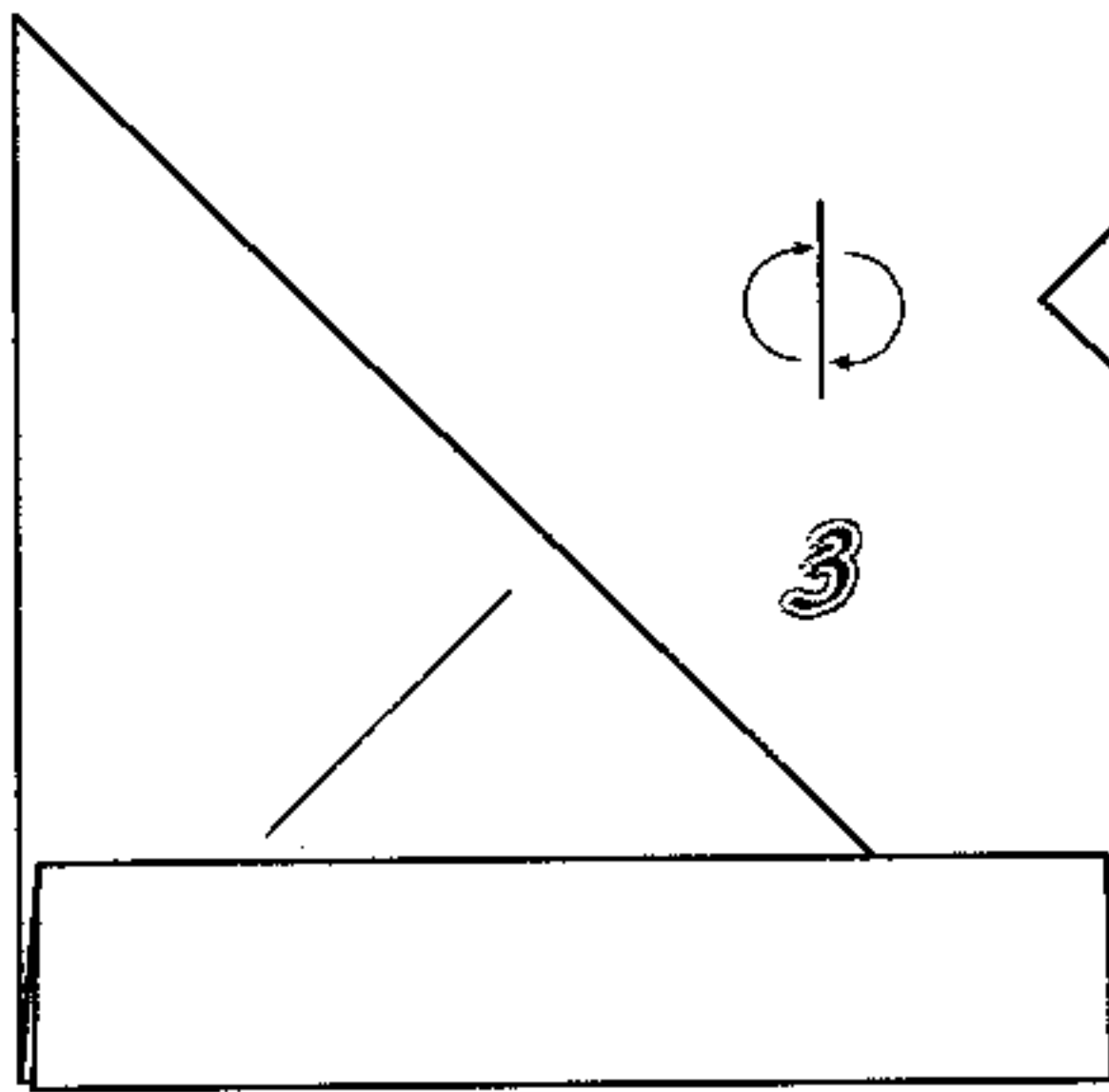
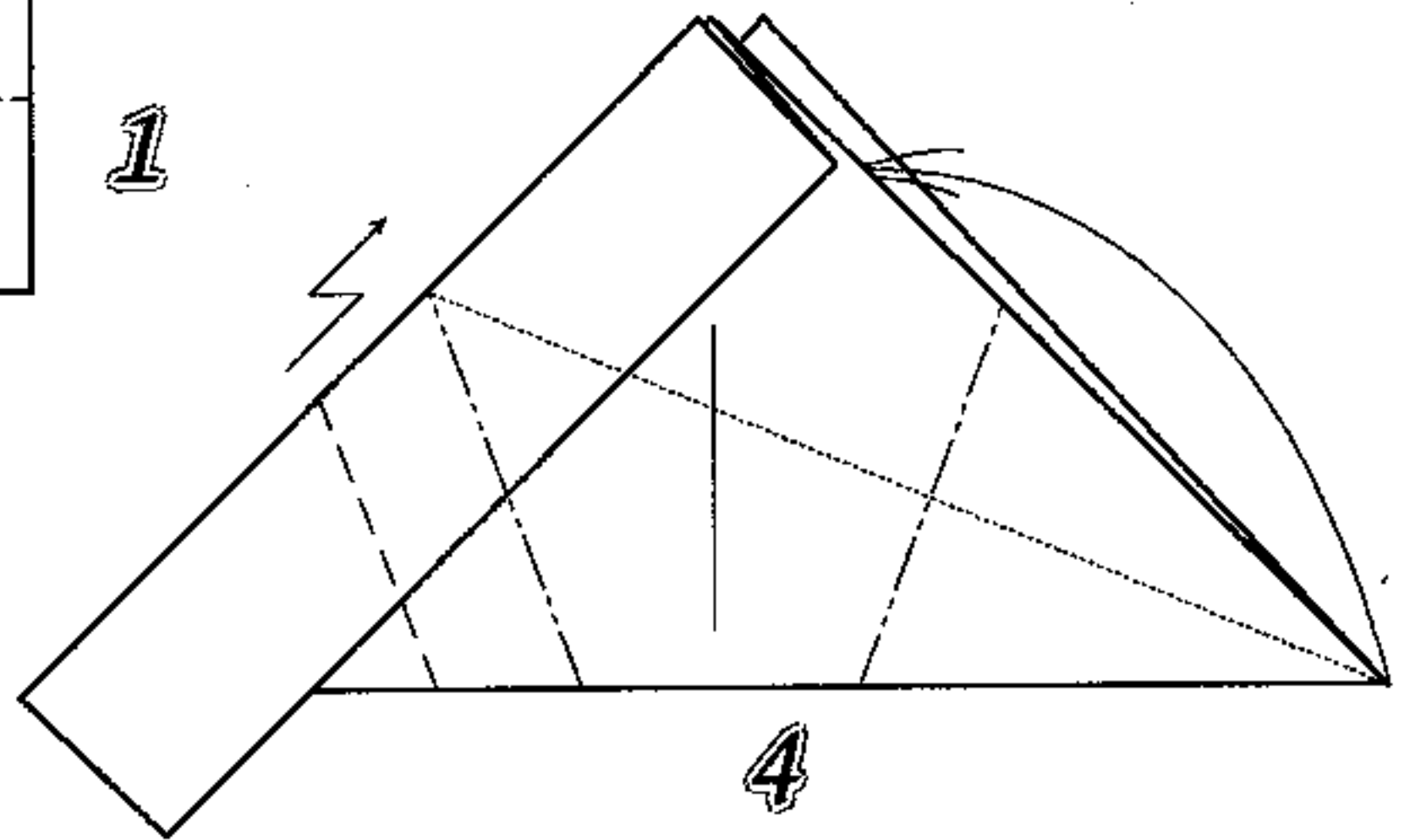

3

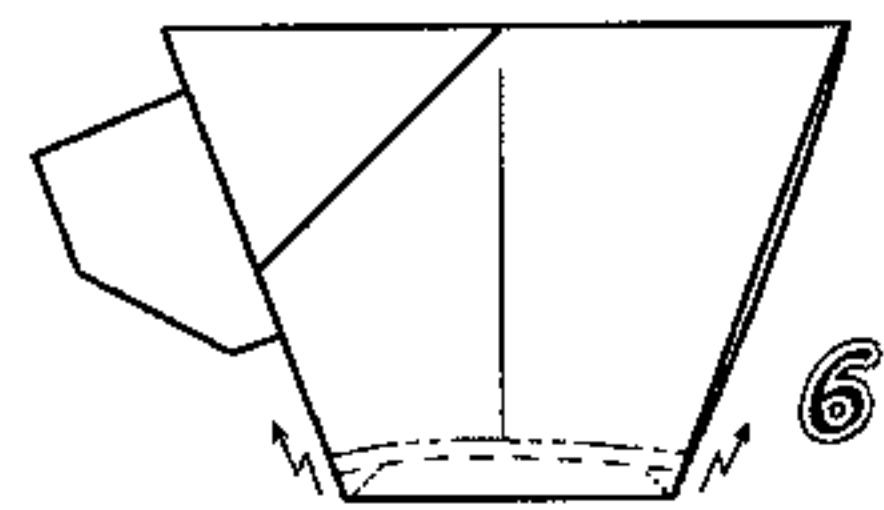

redondear y dar forma al gusto

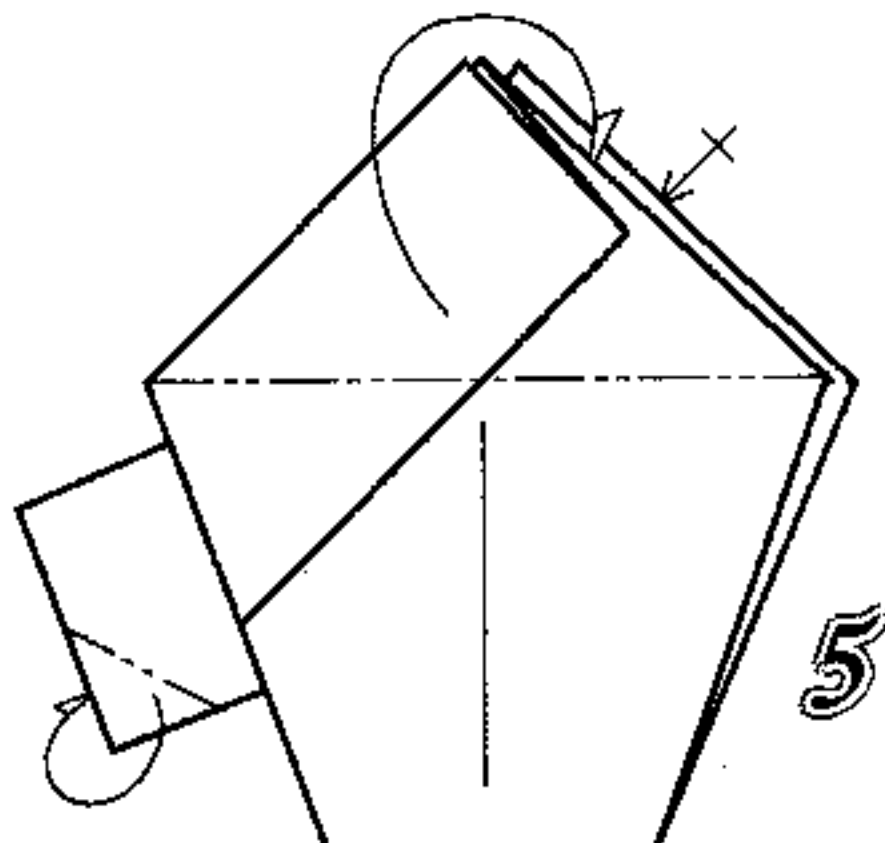

Introducir la solapa anterior atrapando las dos hojas interiores, para así lograr más consistencia.

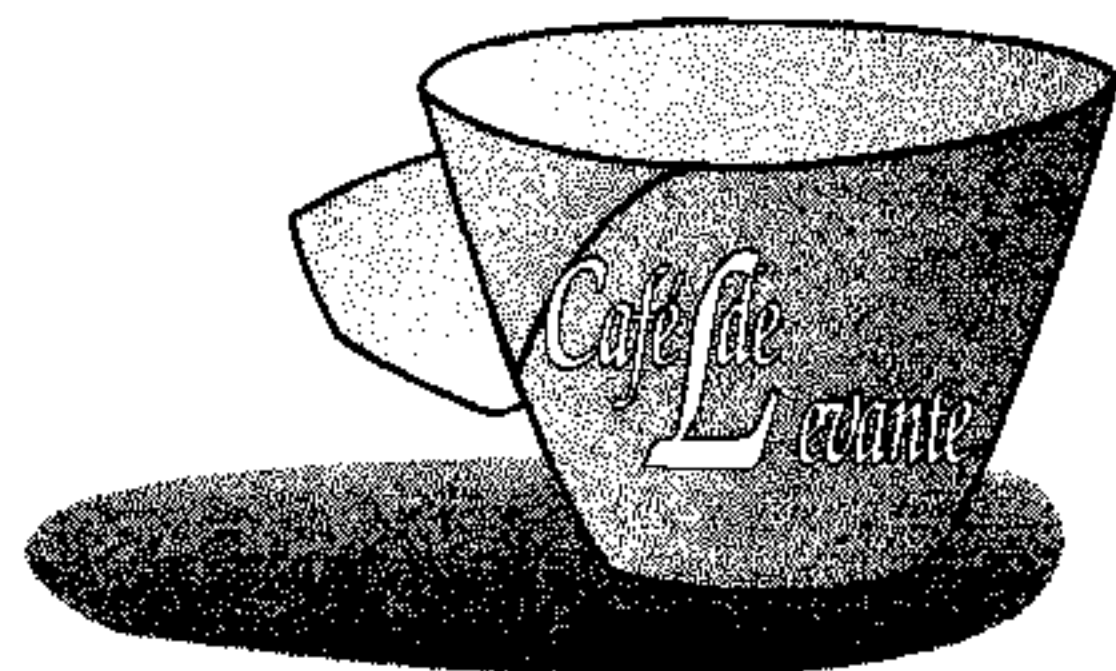

dibujos: J. Felipe Moreno